

Konusedempers

Art.Code	L (mm)	Ls (mm)	B (mm)	Bs (mm)	d (mm)	H (mm)	h (mm)	D (mm)	g (mm)
13100140	120	90	100	74	11	81	20	93	16
13100155	120	90	100	74	11	81	20	93	16
13100170	120	90	100	74	11	81	20	93	16

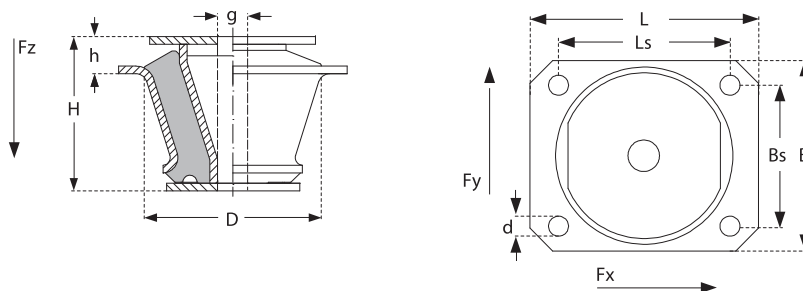

Belasting Fx, Fy

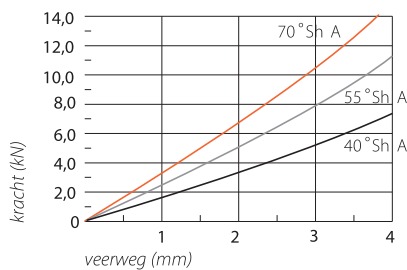

Konusedempers worden standaard met 2 aanslagschijven geleverd.

Rubberkwaliteit: natuurrubber
Rubberhardheid: 40° Shore A
 55° Shore A
 70° Shore A



Konusdempers

Art.Code	L (mm)	Ls (mm)	B (mm)	Bs (mm)	d (mm)	H (mm)	h (mm)	D (mm)	g (mm)
13100540	107	80	90	65	11	58	21,5	78	16
13100560	107	80	90	65	11	58	21,5	78	16
13100570	107	80	90	65	11	58	21,5	78	16

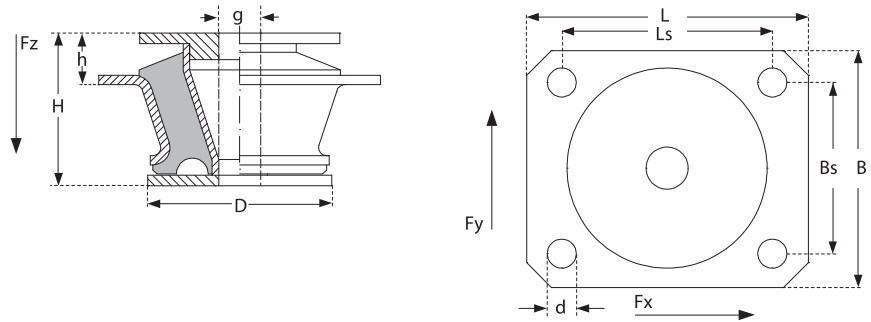

Belasting Fx, Fy

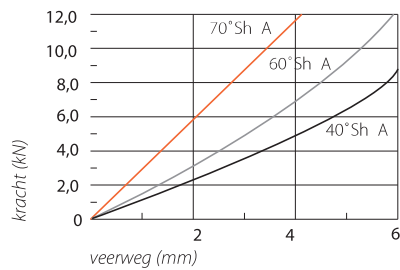

Konusdempers worden standaard met 2 aanslagschijven geleverd.

Rubberkwaliteit: natuurrubber
Rubberhardheid: 40° Shore A
 60° Shore A
 70° Shore A



Konusdempers

Art.Code	L (mm)	Ls (mm)	B (mm)	g (mm)	d (mm)	H (mm)	h (mm)	D (mm)
13300240	106	80	68	12,1	11	51	16,5	60
13300255	106	80	68	12,1	11	51	16,5	60
13300270	106	80	68	12,1	11	51	16,5	60

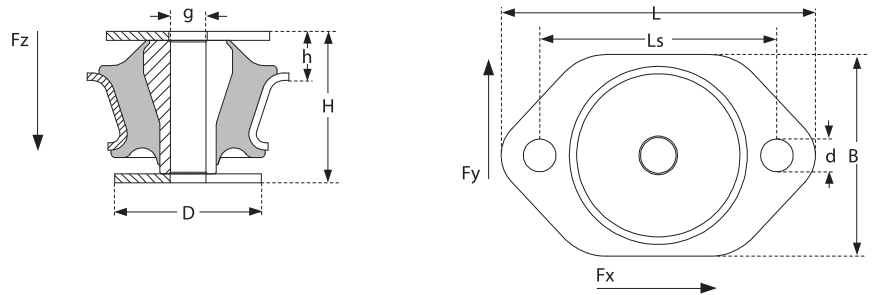

Belasting Fx, Fy

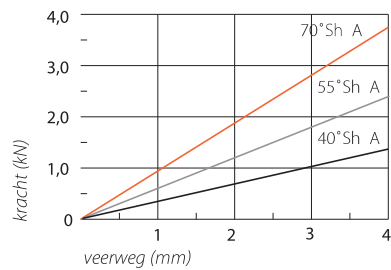

Konusdempers worden standaard met 2 aanslagschijven geleverd.

Rubberkwaliteit: natuurrubber
Rubberhardheid: 40° Shore A
 55° Shore A
 70° Shore A



Konusdempers

Art.Code	L (mm)	Ls (mm)	B (mm)	g (mm)	d (mm)	H (mm)	h (mm)	D (mm)
13500140	84	64	50	8	6,5	27,5	12	46
13500160	84	64	50	8	6,5	27,5	12	46
13500170	84	64	50	8	6,5	27,5	12	46

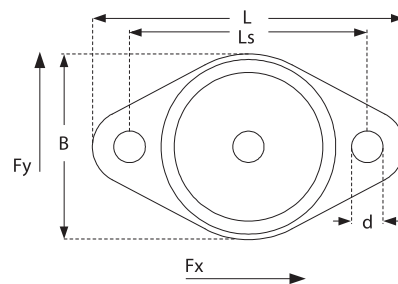
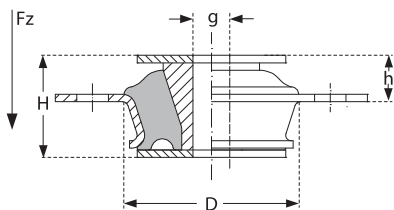

Belasting Fx, Fy

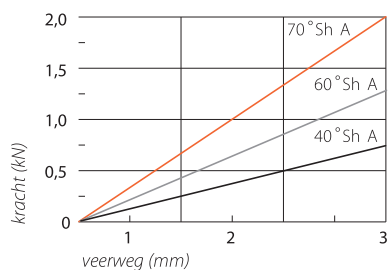

Konusdempers worden standaard met 2 aanslagschijven geleverd.

Rubberkwaliteit: natuurrubber
Rubberhardheid: 40° Shore A
 60° Shore A
 70° Shore A



Konusdempers

Art.Code	L (mm)	Ls (mm)	B (mm)	Bs (mm)	d (mm)	H (mm)	h (mm)	D (mm)	g (mm)
13600140	140	112	120	92	11	95	23	109	20
13600160	140	112	120	92	11	95	23	109	20
13600170	140	112	120	92	11	95	23	109	20

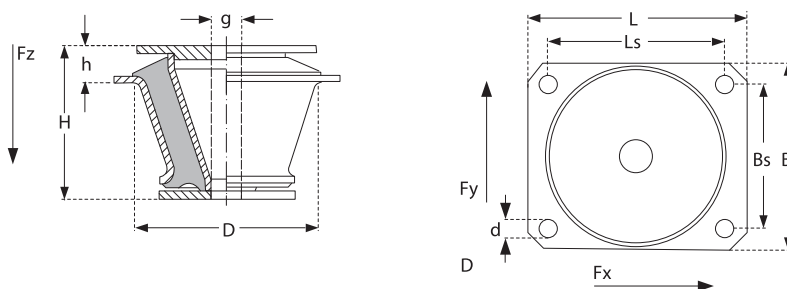

Belasting Fz

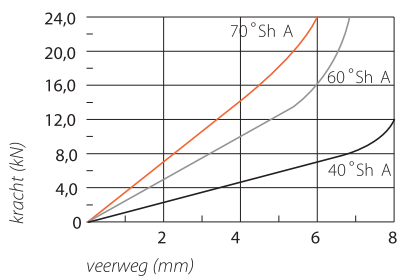

Konusdempers worden standaard met 2 aanslagschijven geleverd.

Rubberkwaliteit: natuurrubber
Rubberhardheid: 40° Shore A
 60° Shore A
 70° Shore A



Art.Code	D (mm)	D1 (mm)	D2 (mm)	g (mm)	H (mm)	h (mm)	S (mm)	L (mm)	Ls (mm)	Bs (mm)	B (mm)	d (mm)
P1550A45	139	124	40	25	100	46	12,5	172	144	100	150	11

P1550A45

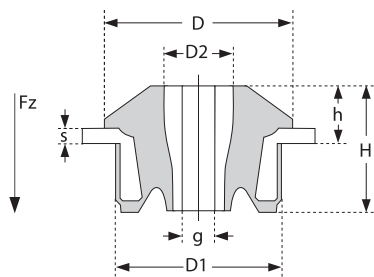

P1550A45

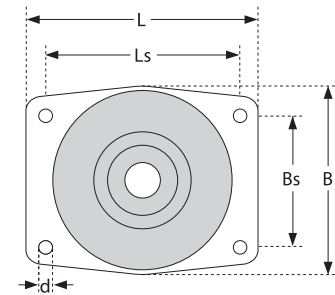

Belasting Fz

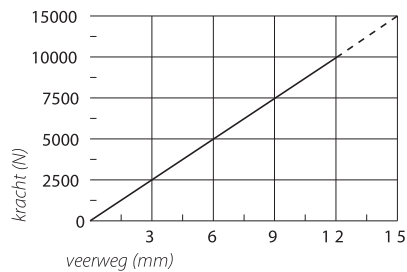

- Robuuste constructie
- Doorslag beveiligd indien gemonteerd met aanslagschijven
- Geschikt voor het opvangen van grote schokbelastingen en trillingen



Konusedempers

Art.Code	L (mm)	Ls (mm)	B (mm)	g (mm)	d (mm)	H (mm)	h (mm)	D (mm)
13201236	89	73	54	10,5	8,7	30	10,3	50
13201260	89	73	54	10,5	8,7	30	10,3	50

Rubberkwaliteit: natuurrubber
Rubberhardheid: 40° en 60° Shore A

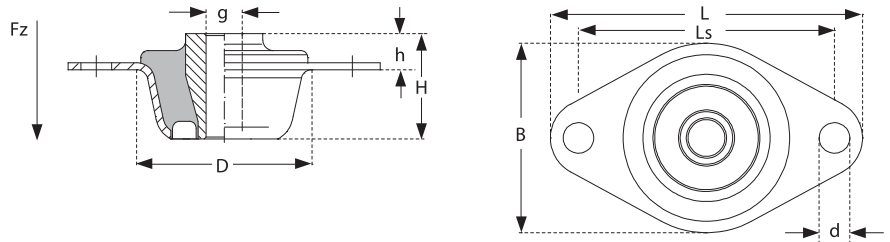

Belasting Fz

