

Parabolische aanslagdempers

type KP/D

Art.Code	D (mm)	H (mm)	M (mm)	L Spindellengte (mm)
KP3030D	30	30	M6	12
KP3036D	30	36	M8	8 10 13 16 18 20 23 27
KP5058D	50	58	M10	15 20 28 33
KP5068D	50	68	M8	15 20 28 33 36
KP7589D	75	89	M12	27 37
KP9580D	95	80	M16	45
KP115133D	115	133		45

Kolom L: vetgedrukt zijn voorraadmaten, overige maten zijn op aanvraag leverbaar

Materiaal: natuurrubber. Standaard leverbaar in: 40° ± 5° Shore A, 55° ± 5° Shore A, 70° ± 5° Shore A.

Type KP/D

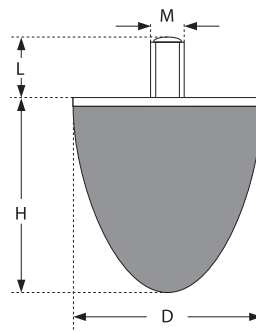

Type KP 50x68 D

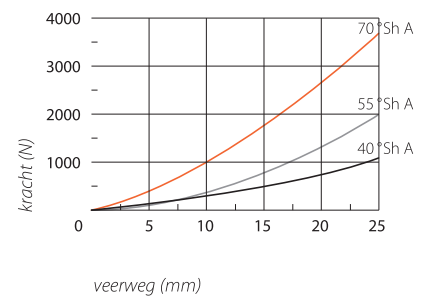

Type KP 30x36 D

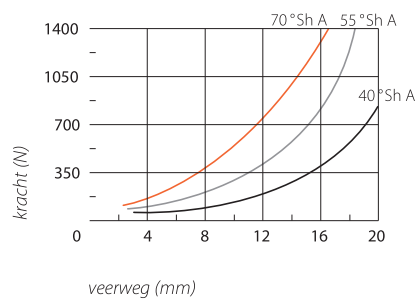

Type KP 75x89 D

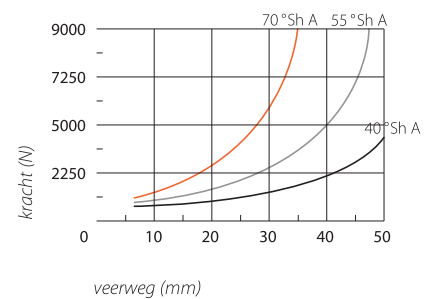

Type KP 50x58 D

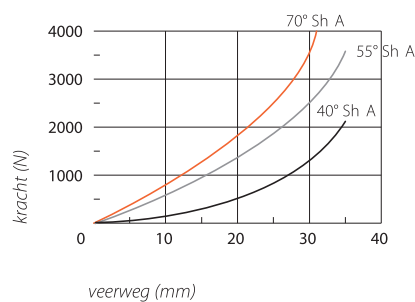

Type KP 115x133 D

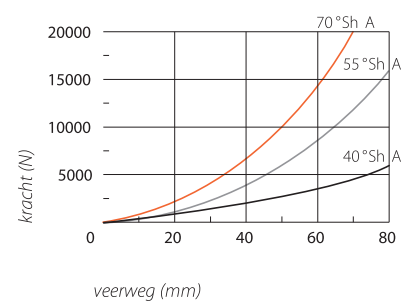

Parabolische aanslagdempers

type KP/E

Art.Code	D (mm)	H (mm)	M (mm)	G (mm)
KP3036E	30	36	M8i	8
KP5058E	50	58	M10i	10
KP5068E	50	68		10
KP7589E	75	89	M12i	12
KP115133E	115	133	M16i	16

Materiaal: natuurrubber. Standaard leverbaar in: $40^\circ \pm 5^\circ$ Shore A, $55^\circ \pm 5^\circ$ Shore A, $70^\circ \pm 5^\circ$ Shore A.

Type KP/E

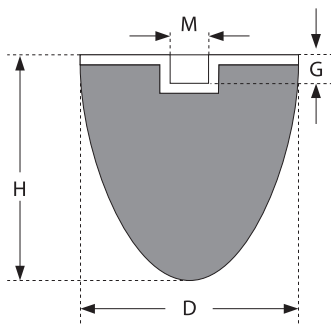

Type KP 50x68 E

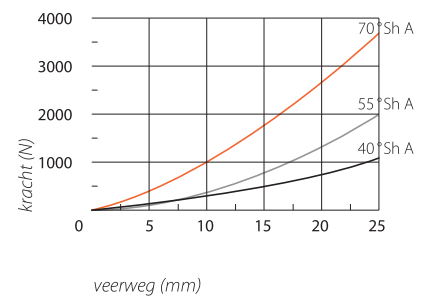

Type KP 75x89 E

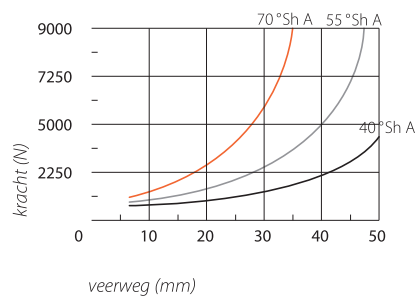

Type KP 30x36 E

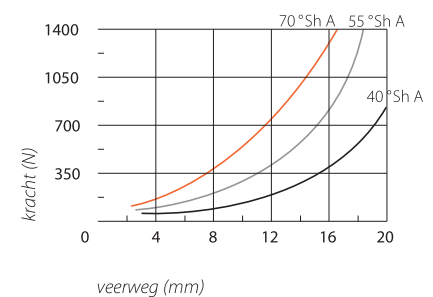

Type KP 50x58 E

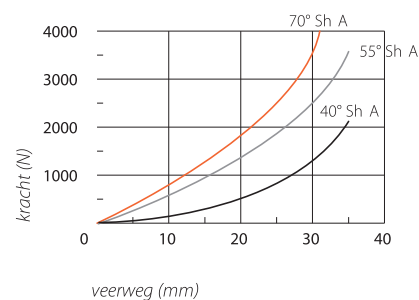

Type KP 115x133 E

