

# Konische aanslagdempers

type K/D

| Art.Code | D<br>(mm)   | H<br>(mm) | M<br>(mm) | L Spindellengte<br>(mm) |
|----------|-------------|-----------|-----------|-------------------------|
| K2517D   | 25          | 17        | M6        | 8 10 12 15 18 20        |
| K4028D   | 40          | 28        | M8        | 13 16 23 28             |
| K4053D   | 40          | 53        | M8        | 13 16 23 28             |
| K5018D   | 50          | 18        | M10       | 15 20 28 33             |
| K5021D   | 50          | 21        | M10       | 15 20 28 33             |
| K5022,5D | 50          | 22,5      | M10       | 15 20 28 33             |
| K5030D   | 50          | 30        | M10       | 15 20 28 33             |
| K5035D   | 50          | 35        | M10       | 15 20 28 33             |
| K5039D   | 50          | 39        | M10       | 15 20 28 33             |
| K6022D   | 60          | 22        | M10       | 15 20 28 33             |
| K7525D   | 75          | 25        | M12       | 27 37                   |
| K7528D   | 75          | 28        | M12       | 27 37                   |
| K8025D   | vierkant 80 | 30        | M12       | 32 37                   |
| K8060D   | 80          | 60        | M12       | 37                      |
| K12545D  | 125         | 45        | M16       | 45                      |
| K12580D  | 125         | 80        | M16       | 45                      |
| K12590D  | 125         | 90        | M16       | 45                      |

Kolom L: vetgedrukt zijn voorraadmaten, overige maten zijn op aanvraag leverbaar

**Materiaal:** natuurrubber

**Standaard leverbaar in:**

40° ± 5° Shore A

55° ± 5° Shore A

70° ± 5° Shore A

Type K/D

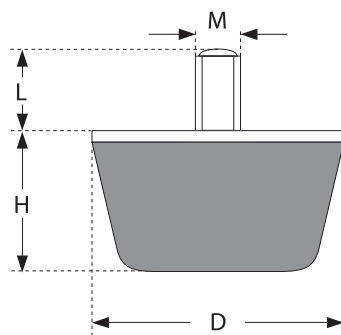

Type K/D K25 x 17

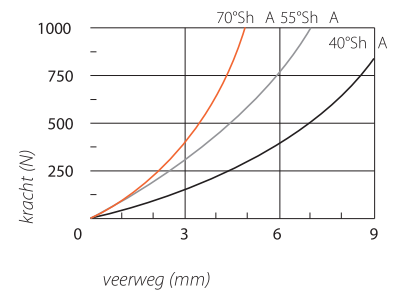

Type K/D K50 x 18

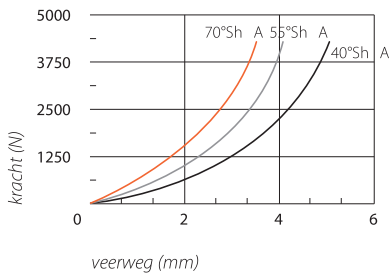

Type K/D K50 x 22,5

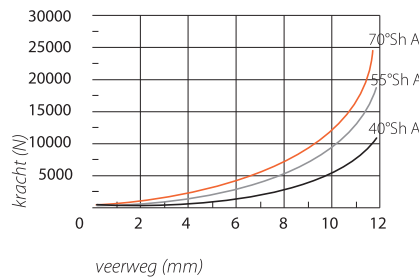

Type K/D K50 x 39

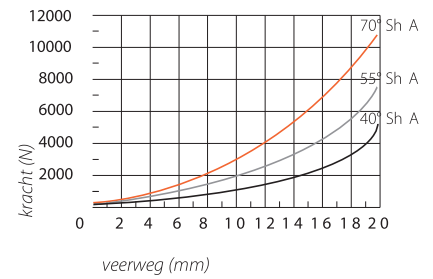

Type K/D K75 x 28

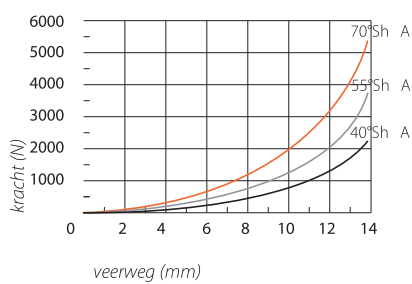

Type K/D K80 x 25

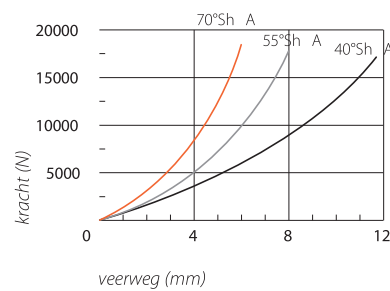

Type K/D K125 x 45

